

IGBT 34mm 半桥模块

Features 产品特性

- 1200V 75A $V_{CE(sat)(typ.)} = 2.5V$
- Planar Field-stop Technology 平面栅场截止技术
- High RBSOA Capability 高 RBSOA 性能
- Low Turn-off Losses 低关断损耗

Typical Application 典型应用

- Inductive Heating 感应加热
- Welding 电焊机
- High Frequency Switch Application 高频开关应用

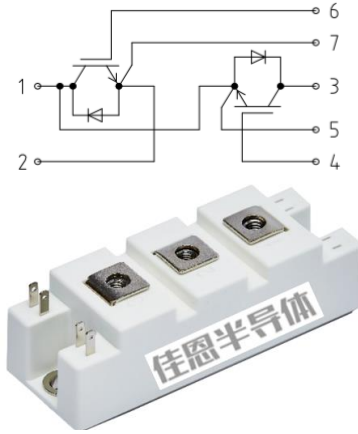

IGBT Maximum Rated Values

Symbol	Parameter	Value	Units
V_{CES}	Collector-Emitter Voltage ($T_{vj}=25^{\circ}C$) 集电极-发射极电压	1200	V
V_{GES}	Gate-Emitter Voltage 栅极-发射极峰值电压	± 20	V
I_C	Continuous Collector Current ($T_C=80^{\circ}C, T_{vj\ max}=150^{\circ}C$) 集电极连续直流电流	75	A
I_{CRM}	Repetitive Peak Collector Current 集电极可重复峰值电流	150	A
P_D	Maximum Power Dissipation ($T_C=25^{\circ}C, T_{vj\ max}=150^{\circ}C$) 总功率损耗	445	W

IGBT Characteristics

Symbol	Parameter	Test Condition	Min	Typ	Max	Units
$V_{CE(sat)}$	Collector-Emitter Saturation Voltage 集电极-发射极饱和压降	$V_{GE}=15V, I_C=75A, T_{vj}=25^{\circ}C$	-	2.5	3.1	V

		$V_{GE}=15V, I_C=75A, T_{vj}=125^\circ C$		3.0			
		$V_{GE}=15V, I_C=75A, T_{vj}=150^\circ C$	-	3.0	-		
$V_{GE(th)}$	Gate Threshold Voltage 栅极阈值电压	$V_{GE}=V_{CE}, I_C=1mA, T_{vj}=25^\circ C$	5.0	6.0	7.0	V	
Q_g	Total Gate Charge 栅极电荷	$V_{GE}=-15V \dots +15V$	-	0.53		μC	
R_{Gint}	Internal Gate Resistor 内置栅极电阻	$T_{vj}=25^\circ C$		5		Ω	
C_{ies}	Input Capacitance 输入电容	$V_{CE}=25V$ $V_{GE}=0V$ $f=1MHz$	-	3.2	-	nF	
C_{res}	Reverse Transfer Capacitance 反向传输电容		-	0.15	-	nF	
I_{CES}	Collector-Emitter Leakage Current 集电极-发射极关断漏电流	$V_{CE}=1200V, V_{GE}=0V$ $T_{vj}=25^\circ C$	-	-	1.0	mA	
I_{GES}	Gate-Emitter Leakage Current, Forward 栅极发射极漏电流	$V_{GE}=20V, V_{CE}=0V, T_{vj}=25^\circ C$	-	-	200	nA	
	Gate-Emitter Leakage Current, Reverse 栅极发射极反向漏电流	$V_{GE}=-20V, V_{CE}=0V, T_{vj}=25^\circ C$	-	-	-200	nA	
$t_{d(on)}$	Turn-on Delay Time 开通延迟时间, 感性负载	$V_{CE} = 600V$ $I_C = 75A$	$T_{vj}=25^\circ C$ 125 $^\circ C$ 150 $^\circ C$	-	38 39 39	- - -	ns
t_r	Turn-on Rise Time 上升时间, 感性负载	$V_{GE} = \pm 15V$ $R_{Gon} = 1.0\Omega$	$T_{vj}=25^\circ C$ 125 $^\circ C$ 150 $^\circ C$	-	25 28 30	- - -	ns
$t_{d(off)}$	Turn-off Delay Time 关断延迟时间, 感性负载	$V_{CE} = 600V$ $I_C = 75A$	$T_{vj}=25^\circ C$ 125 $^\circ C$ 150 $^\circ C$	-	160 195 200	- - -	ns
t_f	Turn-off Fall Time 下降时间, 感性负载	$V_{GE} = \pm 15V$ $R_{Goff} = 1.0\Omega$	$T_{vj}=25^\circ C$ 125 $^\circ C$ 150 $^\circ C$	-	30 80 105	- - -	ns
E_{on}	Turn-on Switching Loss 开通损耗, 感性负载	$V_{CE} = 600V$ $I_C = 75A$ $V_{GE} = \pm 15V$	$T_{vj}=25^\circ C$ 125 $^\circ C$ 150 $^\circ C$	-	5.7 9.0 10.0	- - -	mJ
E_{off}	Turn-off Switching Loss 关断损耗, 感性负载	$R_{Gon} = 1.0\Omega$ $R_{Goff} = 1.0\Omega$ $L_\sigma = 80nH$	$T_{vj}=25^\circ C$ 125 $^\circ C$ 150 $^\circ C$	-	2.4 3.8 4.0	- - -	mJ

$R_{th\ j-c}$	Thermal Resistance, Junction to Case 结-壳热阻	Per IGBT/单个 IGBT	-	0.28	-	K/W
$T_{vj\ op}$	Temperature Under Switching Condition 工作温度		-40	-	150	°C

Diode Maximum Rated Values

Symbol	Parameter	Value	Units
V_{RRM}	Repetitive Peak Reverse Voltage 可重复反向峰值电压	1200	V
I_F	Continuous DC Forward Current 可连续正向直流电流	75	A
I_{FRM}	Repetitive Peak Collector Current 可重复正向峰值电流	150	A

Diode Characteristics

Symbol	Parameter	Test Conditions	Min.	Typ.	Max.	Units
V_F	Diode Forward Voltage 正向通态压降	$I_F = 75A$ $V_{GE} = 0V$		$T_{vj}=25^\circ C$ 1.9 $125^\circ C$ 1.95 $150^\circ C$ 1.95	2.5	V
I_{RM}	Peak Reverse Recovery Current 反向恢复峰值电流			$T_{vj}=25^\circ C$ 60 $125^\circ C$ 60 $150^\circ C$ 60	-	A
Q_{rr}	Reverse Recovery Charge 反向恢复电荷	$I_C = 75A$ $V_R = 600V$ $-di/dt = 1400A/\mu s$ $V_{GE} = -15V$		$T_{vj}=25^\circ C$ 4.7 $125^\circ C$ 8.7 $150^\circ C$ 10.0	-	μC
E_{rec}	Reverse Recovery Energy 反向恢复损耗			$T_{vj}=25^\circ C$ 2.2 $125^\circ C$ 4.0 $150^\circ C$ 4.8	-	mJ
$R_{th\ j-c}$	Thermal Resistance, Junction to Case 结-壳热阻	Per Diode/ 单个 Diode	-	0.51		K/W
$T_{vj\ op}$	Temperature Under Switching Condition 工作温度		-40	-	150	°C

Module

Symbol	Parameter	Test Conditions	Min.	Typ.	Max.	Units
R_{thc-h}	Thermal Resistance, Case to Heatsink 外壳-散热片热阻	Per Module/每个模块		0.05		K/W
L_{sCE}	Stray Inductance Module 模块杂散电感			30		nH
$R_{CC'+EE'}$ $R_{AA'+CC'}$	Module Lead Resistance, Terminals-Chip 模块引脚电阻, 端子-芯片	$T_C = 25^\circ\text{C}$, Per Switch 每个开关		0.65		m Ω
T_{stg}	Storage Temperature 存储温度		-40		125	$^\circ\text{C}$
M	Module Mounting Torque 模块安装扭矩	M6 screws	3.0		5.0	Nm
M	Terminal Mounting Torque 端子安装扭矩	M5 screws	2.5		6.0	Nm
G	Weight 重量			145		g

V_{iso}	Isolation Test Voltage 绝缘测试电压	RMS, f=50 Hz, t=1 min		3.0		kV
	Material of Module Baseplate 模块底板材料			Cu		
	Internal Isolation 内部绝缘	basic insulation (class 1, IEC 61140) 基本绝缘(class 1, IEC 61140)		Al_2O_3		
	Clearance Distance in Air 电气间隙	Terminal to heatsink 端子-散热片		17		mm
		Terminal to terminal 端子-端子		9.5		
	Surface Creepage Distance 爬电距离	Terminal to heatsink 端子-散热片		17		mm
		Terminal to terminal 端子-端子		20		
CTI	Comparative Tracking Index 相对漏电起痕指数			>200		

Typical Performance Characteristics

IGBT output characteristics (typical)

$$I_C = f(V_{CE})$$

$$V_{GE} = 15V$$

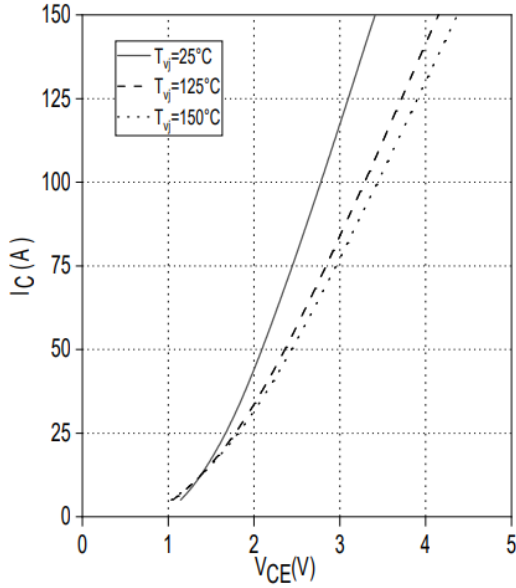

IGBT output characteristics (typical)

$$I_C = f(V_{CE})$$

$$T_{vj} = 150^\circ C$$

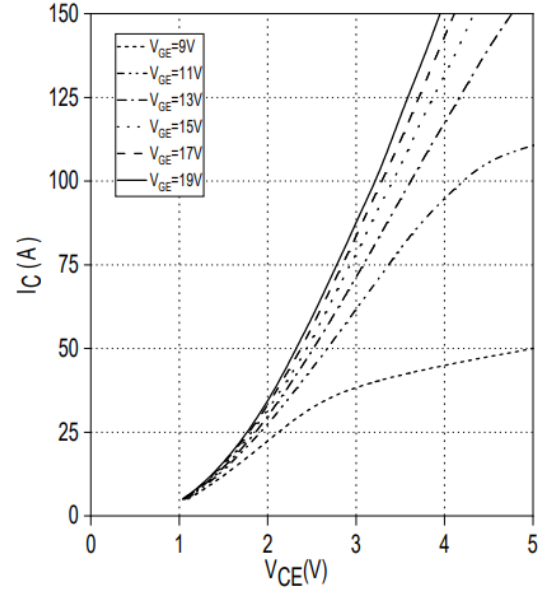

IGBT Transfer characteristics (typical)

$$I_C = f(V_{CE})$$

$$V_{CE} = 20V$$

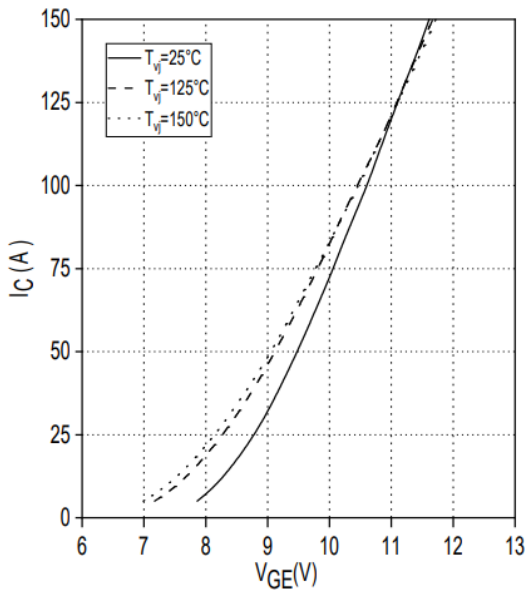

IGBT Switching losses (typical)

$$E_{on} = f(I_C), E_{off} = f(I_C), V_{GE} = \pm 15V$$

$$R_{Gon} = 1.0\Omega, R_{Goff} = 1.0\Omega, V_{CE} = 600V$$

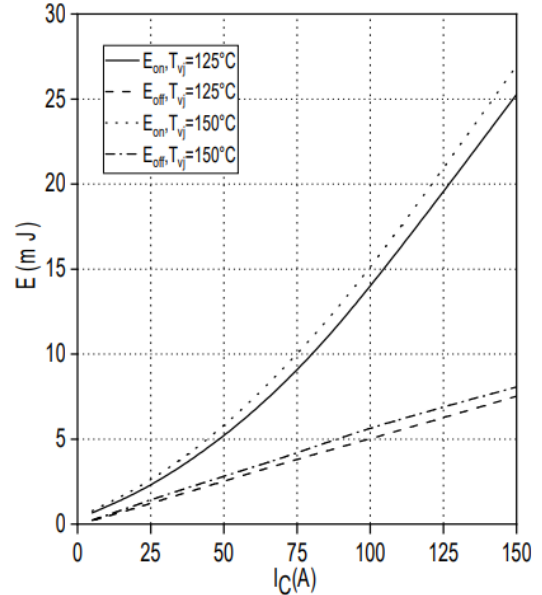

IGBT Switching losses (typical)

$V_{GE} = \pm 15V, I_C = 75A, V_{CE} = 600V$

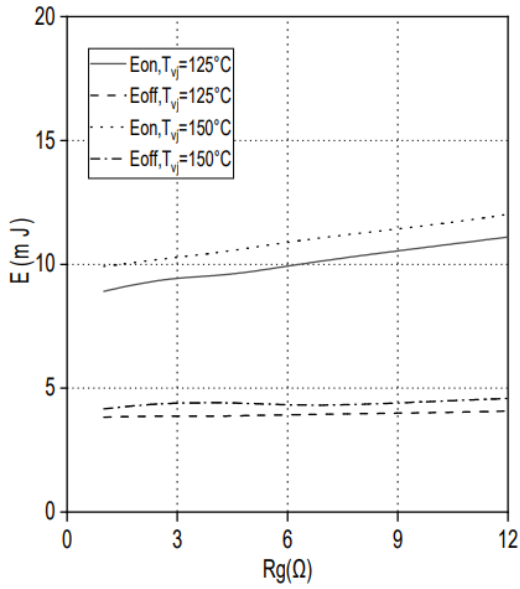

IGBT Transient thermal impedance

$Z_{thJC} = f(t)$

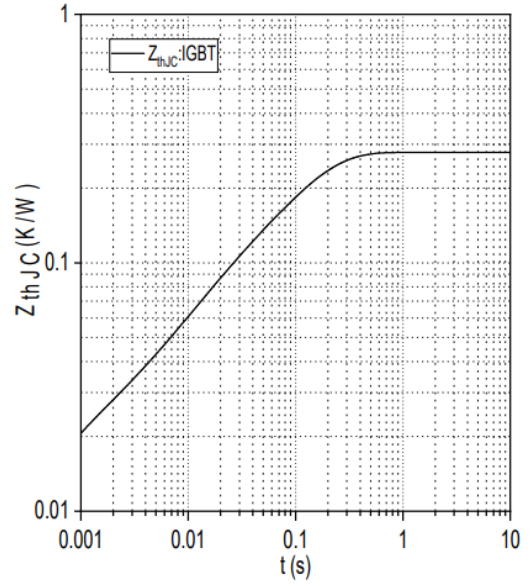

IGBT Reverse bias safe operating area (RBSOA)

$I_C = f(V_{CE})$

$V_{GE} = \pm 15V, R_{Goff} = 1.0\Omega, T_{vj} = 150^\circ C$

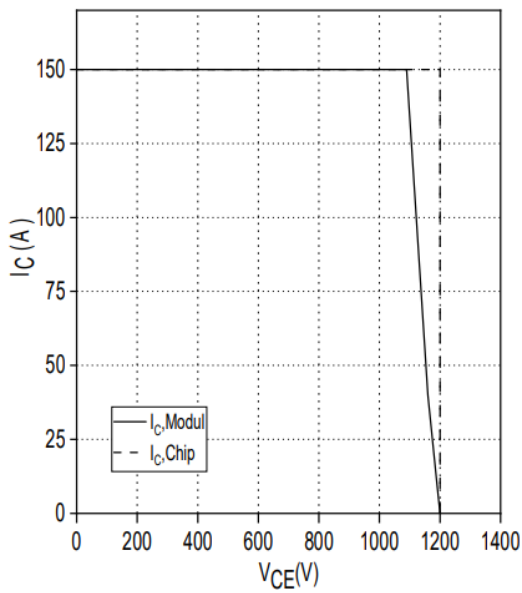

Diode Forward characteristics

$I_F = f(V_F)$

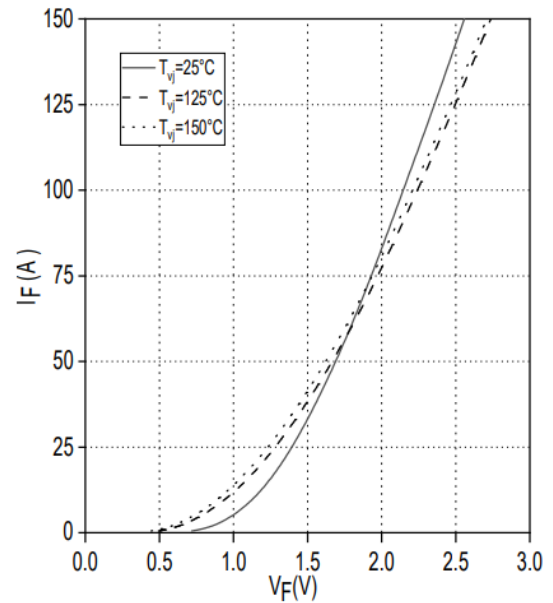

Diode Switching losses (typical)

$$E_{rec} = f(I_F)$$

$R_{on} = 1.0\Omega, V_{CE} = 600V$

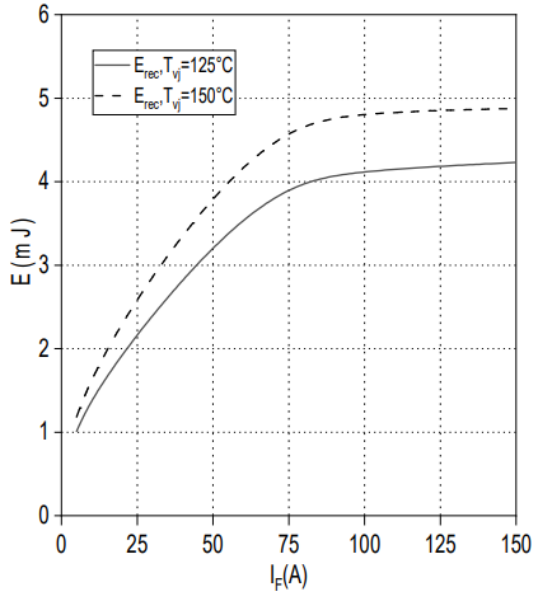

Diode Switching losses (typical)

$$E_{rec} = f(R_G)$$

$I_F = 75A, V_{CE} = 600V$

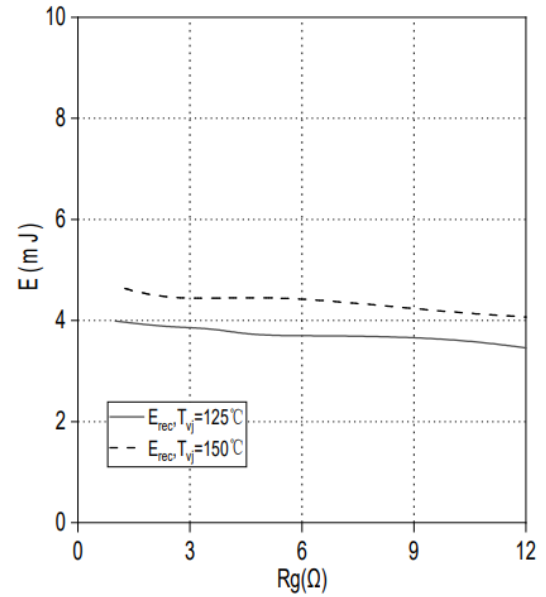

Diode Transient thermal impedance

$$Z_{thJC} = f(t)$$

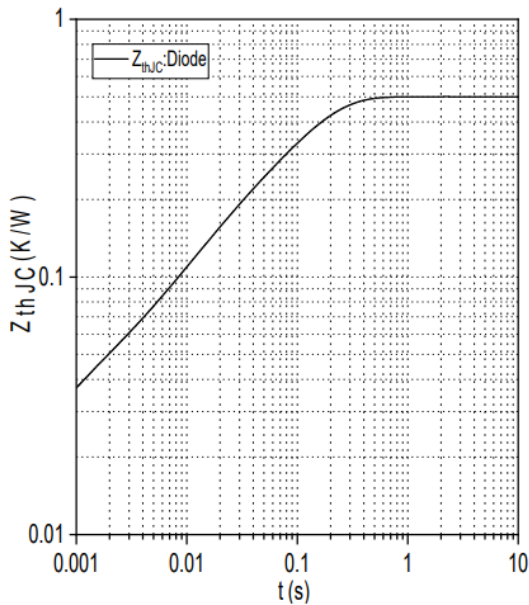

Internal Circuit

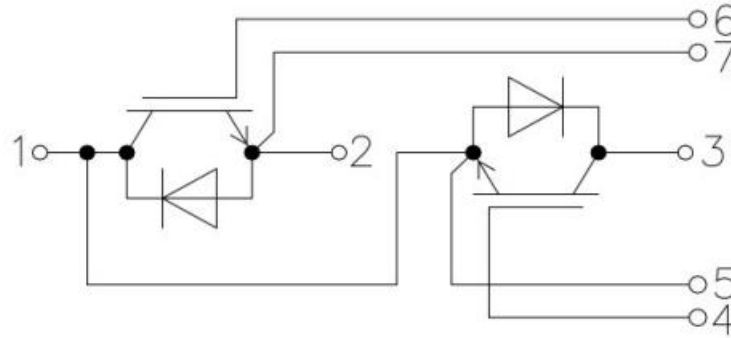

Package Dimension(unit: mm)

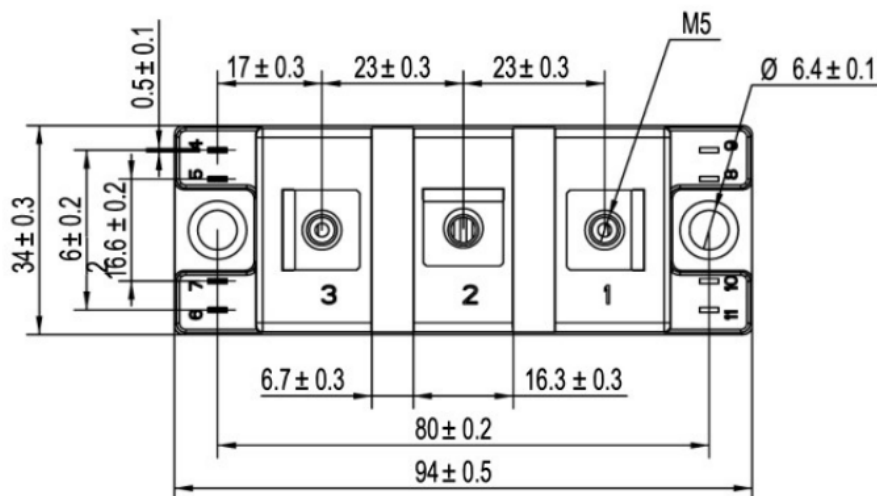
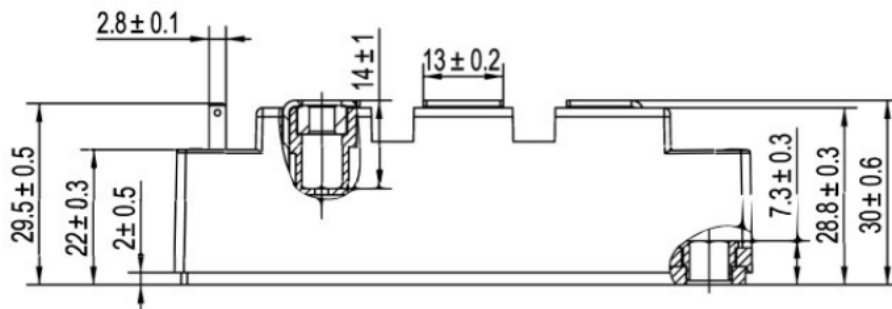

Disclaimers

JIAEN Semiconductor Co., Ltd reserves the right to make changes without notice in order to improve reliability, function or design and to discontinue any product or service without notice. Customers should obtain the latest relevant information before orders and should verify that such information is current and complete. All products are sold subject to JIAEN's terms and conditions supplied at the time of order acknowledgement.

JIAEN Semiconductor Co., Ltd warrants performance of its hardware products to the specifications at the time of sale, Testing, reliability and quality control are used to the extent JIAEN deems necessary to support this warrantee. Except where agreed upon by contractual agreement, testing of all parameters of each product is not necessarily performed.

JIAEN Semiconductor Co., Ltd does not assume any liability arising from the use of any product or circuit designs described herein. Customers are responsible for their products and applications using JIAEN's components. To minimize risk, customers must provide adequate design and operating safeguards.

JIAEN Semiconductor Co., Ltd does not warrant or convey any license either expressed or implied under its parent rights, nor the rights of others. Reproduction of information in JIAEN's datasheets or data books is permissible only if reproduction is without modification or alteration. Reproduction of this information with any alteration is an unfair and deceptive business practice. JIAEN Semiconductor Co., Ltd is not responsible or liable for such altered documentation.

Resale of JIAEN's products with statements different from or beyond the parameters stated by JIAEN Semiconductor Co., Ltd for that product or service voids all express or implied warranties for the associated JIAEN's product or service and is unfair and deceptive business practice. JIAEN Semiconductor Co., Ltd is not responsible or liable for any such statements.